

WPPC-133W1-C Series

13.3 inch Capacitive Touch Panel PC with Intel Celeron J4125 processor

Features

- 13.3-inch Intel J4125 Capacitive Touch Panel PC
- Pure flat and narrow bezel design
- Fanless Design
- Multi installation method optional
- Only front panel IP65 Waterproof
- Compatible CE, RoHS, FCC and CCC certificates.



Specifications

Display Parameter	Size	13.3 inch
	Display Area(mm)	293.76x165.24
	Resolution	1920x1080 (16: 9)
	Color	16.7M
	Brightness	300cd/m2
	Backlight	LED
	Life	50000hrs
	Touch Method	PCAP Projected 10 points capacitive touch
Computer Parater	CPU	Intel® Celeron® Processor J4125
	Cache	4 MB Intel® Smart Cache
	Memory	1*260pin DDR4/LPDDR4 upto 2400 SODDIM (Support max 8G)
	Storage	SSD (32G/128G/256G/512G/1T Msata SSD are optional)
	Operating System	support WIN10/LINUX
	Expansion Card Slot	1*mSATA
	Power Supply	DC12V 5A / AC110V-240V,50-60 Hz
	Power Consumption	7.2W (Max 26.1W)
	Dimension (mm)	355.2x230.2x52.6
	Cutout Size(mm)	326.00x204.00
Appearance Feaure	Enclosure Material	Aluminum Alloy
	Heat Dissipation Method	Built-in cooling FAN
	Waterproof Level	Only front panel IP65
Communication Interface	2* LAN (Realtek 8111H), 2*USB 3.0, 2*USB 2.0, 1*9 WIRES RS-232 and 2*3 WIRES RS232, 2*RS-485, 1*HDMI, 1*VGA, 1*LINE_OUT, 1*MIC_IN and 1*PSON	
	4*Digital Input and 4*Digital Output, 4G and WiFi are Optional watchdog programming, Support hardware reset function (256 levels · 0~255s)	
Working Envoriment	Working Temp.	-20°C -60 °C
	Working Humidity	5%RH -95%RH

Dimension

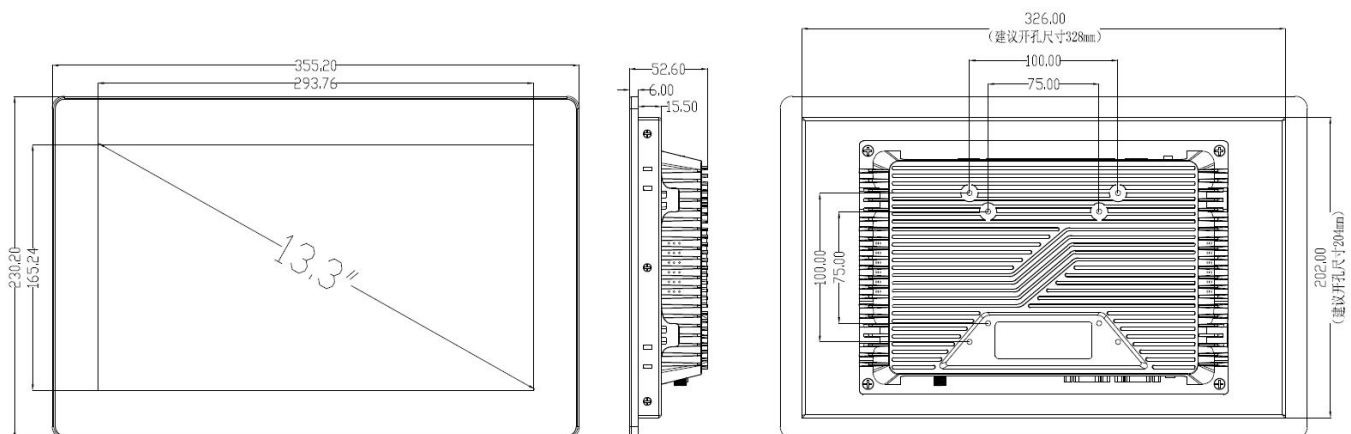

Ordering Information

Model name	Description
WPPC-133W1-C-J4125	13.3-inch Capacitive Touch Panel PC With Intel J4125 , 2*LAN Port, 2*USB 3.0, 2*USB 2.0 , 1*9 WIRES RS-232 and 2*3 WIRES RS232, 2*RS-485, 1*HDMI, 1*LINE_OUT, 1*MIC_IN and 1*PSON
WPPC-133W1-C-J4125-B	13.3-inch Capacitive Touch Panel PC With Intel J4125 , 1*LAN Port, 2*USB 3.0, 4*USB 2.0 , 1*9 WIRES RS-232 and 2*3 WIRES RS232, 2*RS-485, 1*HDMI, 1*LINE_OUT, 1*MIC_IN and 1*PSON